

FP-150 PANEL

Flush Seam Series

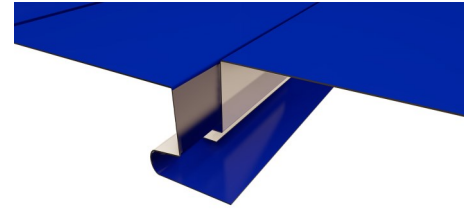

OVERVIEW

The FP-150 Panel is for soffit, wall, and liner applications. It can be installed over solid substrate or on open framing (36" o.c.). Ideal applications include vertical fascias, soffit, equipment screen, and mansard walls. The FP-150 Panel is available with perforated vent strips for soffit vent application

DIAGRAMS

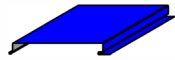

SMOOTH

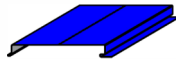

SINGLE ROW OF VENTING



2 ROWS OF VENTING

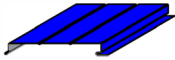

2 PENCIL/V-RIBS



SINGLE ROW OF VENTING, 2 PENCIL/V-RIBS



2 ROWS OF VENTING, 2 PENCIL/V-RIBS

ADJUSTABLE REVEAL
0" TO 3" IN 1/2" INCREMENTS
(0mm TO 76.2mm IN
12.7mm INCREMENTS)

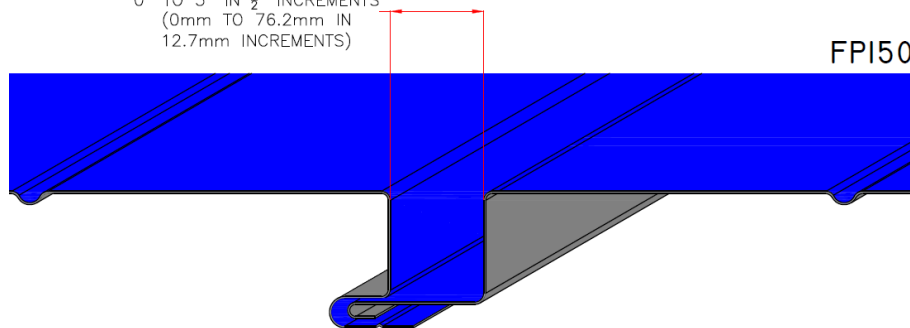

FPI50

MATERIAL	STANDARD WIDTHS	OPTIONAL WIDTHS
24 ga. Steel	11", 15"	12", 17", 19"
22 ga. Steel	11", 15"	12", 17", 19"
.032" Aluminum		Call for Availability
.040" Aluminum		Call for Availability

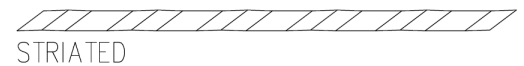

STRIATED

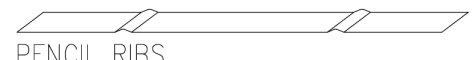

PENCIL RIBS

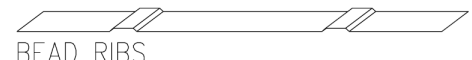

BEAD RIBS

PRODUCT FEATURES

- Versatile panel for soffit, fascia, facade, and walls
- Install over solid substrate or open framing (up to 36" o.c.)
- Available smooth, pencil rib, or v-rib
- Panels expand and contract freely
- Flush seam connections with hidden fasteners
- Roll-formed to exact lengths
- 35 Year finish warranty
- Net free vent area for vented panels (2 rows of perforations) up to 6.04 square inches per lineal foot
- One or two rows of vents are standard